

ABCS GRP Control Stations

IP66

Application

Hazardous and Industrial areas

Protection Degree

IP66

Certification

Ex db eb IIC T5 Gb

Ex eb IIC T5 Gb (Ammeter only)

Ex tb IIIC T100°C Db

Standard ambient ranges:

-40°C to +40°C or -40°C to +55°C



Note: Alternative T rating and ambient ranges available, please refer to certificates

Configuration options (see typical layout drawings overleaf)

Part Number	Dimensions WxHxD (mm)	Maximum Populations Guidance*			
		Operators Only	W/ Terminals	W/ Ammeter	W/ Ammeter & Terminals
ABCS6	122x120x90	1 x Op	N/A	N/A	N/A
ABCS7	120x220x90	3 x Op	2 x Op	1 x Op, 1 x Am	1 x Am
ABCS8	160x160x90	4 x Op	2 x Op	1 x Am	N/A
ABCS9	160x260x90	6 x Op	6 x Op	4 x Op, 1 x Am	2 x Op, 1 x Am
ABCS10	160x360x90	10 x Op	8 x Op	4 x Op, 2 x Am	2 x Op, 2 x Am
ABCS11	160x560x90	16 x Op	14 x Op	8 x Op, 3 x Am	6 x Op, 3 x Am
ABCS12	255x250x120	9 x Op	6 x Op	6 x Op, 2 x Am	3 x Op, 2 x Am
ABCS13	250x400x120	18 x Op	15 x Op	9 x Op, 4 x Am	6 x Op, 2 x Am
ABCS14	250x600x120	26 x Op	23 x Op	12 x Op, 6 x Am	9 x Op, 6 x Am
ABCS15	400x405x120	30 x Op	25 x Op	15 x Op, 6 x Am	10 x Op, 6 x Am

* Based on 2 pole operators. 4 pole options are available, please contact sales for more information.

Available operator, ammeter and terminal types (see parts list overleaf)

Push Button	Momentary, 1NC/1NO, 2NC or 2NO contacts. Coloured/marked inserts as required
Emergency Stop	Push-Pull, Twist-to-release or Key Release, 1NC/1NO, 2NC or 2NO contacts. Red/yellow mushroom head. Also available with padlockable guard.
Mushroom Head	Momentary, 1NC/1NO, 2NC or 2NO contacts. Colour: black, green or red
Indicator Lamp	Red/green/yellow/blue or white available
Illuminated Push Button	Red/green/yellow/blue or white available. Available with 1NC or 1NO contacts
Selector Switch	2 or 3 position. 2-pole contact configurations and label inserts to suit application Small switch handle (39mm dia) as standard. Large handle (60mm dia) also available
Key Switch	2 or 3 position. 2-pole contact configurations to suit application
Ammeter	Direct measuring with x2 overload scale (max scale: 0-15A/30A) 1A or 5A current transformer with x2 or x5 overload scale (max scale: 0-600A/3000A)
Voltmeter	Several measuring ranges available from 0-25Vac to 0-500Vac
Terminals	Direct termination as standard, 2.5/4mm ² Ex screw terminals fitted where requested to pertinax mounting plate

Maximum Cable Entries

	Top or Bottom face				Side face			
	M20	M25	M32	M40	M20	M25	M32	M40
ABCS6	2	1	1	N/A	1	1	N/A	N/A
ABCS7	1	1	N/A	N/A	4	3	3	N/A
ABCS8	2	2	1	N/A	2	1	1	N/A
ABCS9	2	2	1	N/A	6	4	3	N/A
ABCS10	2	2	1	N/A	8	6	5	N/A
ABCS11	2	2	1	N/A	12	10	8	N/A
ABCS12	10	6	3	3	8	4	2	2
ABCS13	8	4	2	2	16	14	6	5
ABCS14	8	4	2	2	24	20	8	6
ABCS15	18	14	6	5	16	10	5	4

Ordering information

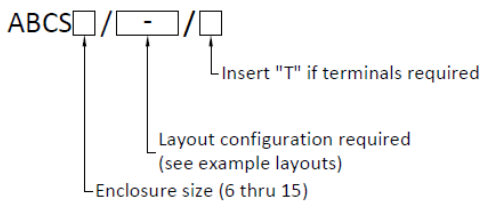

Example Spec Code:

ABCS9/[2-1]/T

P1 = COP17004

P2 = COP17024

A1 = CAM7WA5**/ 1-2 & CZ0205-0-5A/1-2

T = 8 x AKZ 2.5 Ex

ENTRIES = 2 x M20 bottom side

ABCS9 control station (160x260x90mm), fitted with:

- 1 off Momentary pushbutton, 1NC/1NO contacts, green "START" label insert
- 1 off Momentary pushbutton, 1NC/1NO contacts, red "stop" label insert
- 1 off ammeter for connection to 1A CT, 0-5A measuring scale with x2 overload scale (10A)
- 8 off AKZ 2.5 Ex terminals mounted horizontally
- 2 off M20 entries in bottom side of enclosure

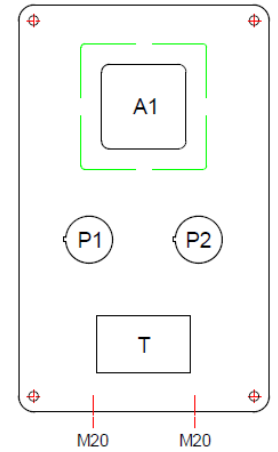









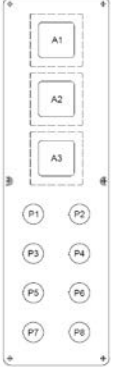
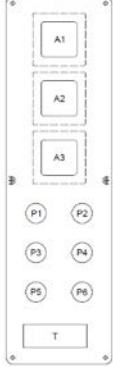

Electrical data

Contact Block for: Push Button Emergency Stop Mushroom Head Selector / Key Switch	Utilization category (per BS EN 60947-1)	AC12	AC15	DC13	DC13
	Rated voltage	250V	250V	110V	24V
	Rated current	16A	10A	0.5A	1A
	Maximum ambient temperature	+40°C	+60°C	+60°C	+60°C
Indicator Lamp Module	Suitable for 20-250Vac/dc supply. Alternative supply option: 250-400Vac				
Illuminated Push Button Module	Utilization category (per BS EN 60947-1)	AC15		DC13	
	Rated voltage	250V		24V	
	Rated current	10A		1A	
	Maximum ambient temperature	+60°C		+60°C	
Lamp suitable for 12-250Vac/dc supply					
Terminals	Terminal type	AKZ 2.5	AKZ 4	SAK 2.5	SAK 4
	Maximum cable size	2.5mm ²	4mm ²	2.5mm ²	4mm ²
	Maximum voltage	176V	275V	550V	550V
	Maximum current	15A**	28A	15A**	28A



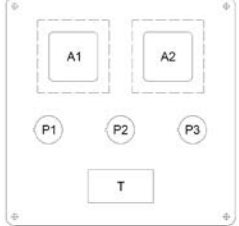

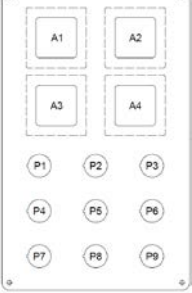
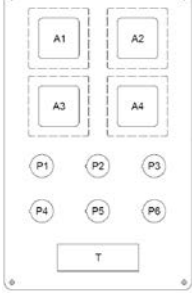
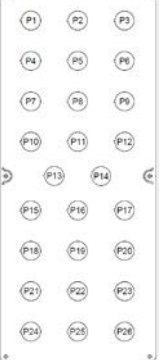
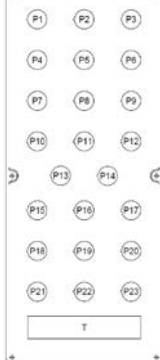
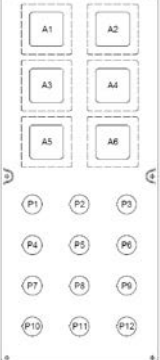
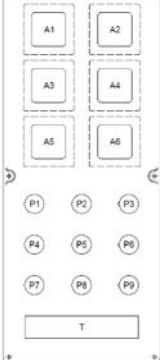

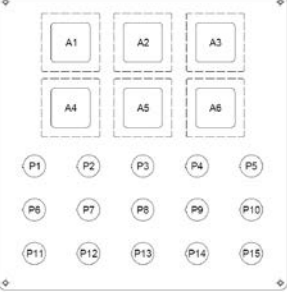
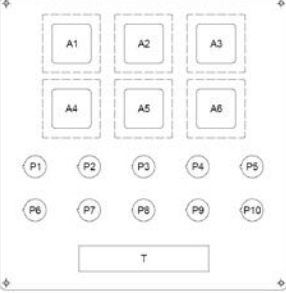

**limited as per hazardous area certificate

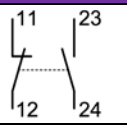

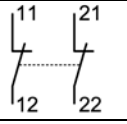
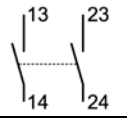
Example Layout Drawings

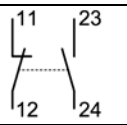
OPERATORS ONLY	W/ TERMINALS	W/ AMMETER	W/ AMMETER & TERMINALS
 <p>ABCS6/1-0</p>			
 <p>ABCS7/3-0</p>	 <p>ABCS7/2-0/T</p>	 <p>ABCS7/1-1</p>	 <p>ABCS7/0-1/T</p>
 <p>ABCS8/4-0</p>	 <p>ABCS8/2-0/T</p>	 <p>ABCS8/0-1</p>	
 <p>ABCS9/6-0</p>	 <p>ABCS9/6-0/T</p>	 <p>ABCS9/4-1</p>	 <p>ABCS9/2-1/T</p>
 <p>ABCS10/10-0</p>	 <p>ABCS10/8-0/T</p>	 <p>ABCS10/4-2</p>	 <p>ABCS10/2-2/T</p>

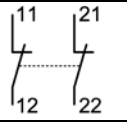
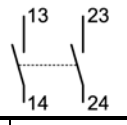



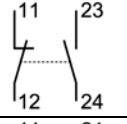

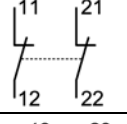
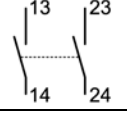

 <p>ABCS11/16-0</p>	<p>ABT31082</p>  <p>ABCS11/14-0/T</p>	<p>ABT31082</p>  <p>ABCS11/8-3</p>	<p>ABT31083</p>  <p>ABCS11/6-3/T</p>
 <p>ABCS12/9-0</p>	<p>ABT31084</p>  <p>ABCS12/6-0/T</p>	<p>ABT31084</p>  <p>ABCS12/6-2</p>	<p>ABT31085</p>  <p>ABCS12/3-2/T</p>
 <p>ABCS13/18-0</p>	<p>ABT31086</p>  <p>ABCS13/16-0/T</p>	<p>ABT31086</p>  <p>ABCS13/9-4</p>	<p>ABT31087</p>  <p>ABCS13/6-4/T</p>
 <p>ABCS14/26-0</p>	<p>ABT31088</p>  <p>ABCS14/23-0/T</p>	<p>ABT31088</p>  <p>ABCS14/12-6</p>	<p>ABT31089</p>  <p>ABCS14/9-6/T</p>
 <p>ABCS15/30-0</p>	<p>ABT31090</p>  <p>ABCS15/25-0/T</p>	<p>ABT31090</p>  <p>ABCS15/15-6</p>	<p>ABT31091</p>  <p>ABCS15/10-6/T</p>

Momentary Push Buttons

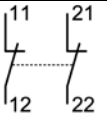
Part Code	Part Description	Contact Configuration	Typical Part Image					
COP170xx	P1 Push button, 1NC/1NO contacts	 11 23 12 24 1NC/1NO						
COP171xx	P1 Push button, 2NC contacts	 11 21 12 22 2NC						
COP172xx	P1 Push button, 2NO contacts	 13 23 14 24 2NO						
<p>OPTION: Add suffix G to the above P1 part codes to include a padlockable guard eg. COP170xxG</p> <p>Note: Padlock not included</p>								
COP270xx/xx	P2 Double Push button, 1NC/1NO contacts	 11 23 12 24 1NC/1NO						
COP271xx/xx	P2 Double Push button, 2NC contacts	 11 21 12 22 2NC						
COP272xx/xx	P2 Double Push button, 2NO contacts	 13 23 14 24 2NO						
	CODE	LEGEND	LABEL COLOUR	TEXT COLOUR	CODE	LEGEND	LABEL COLOUR	TEXT COLOUR
	01	"BLANK"	Green	N/A	41	"BLANK"	White	N/A
	02	I	Green	White	42	II	White	Black
	03	ON	Green	White	43	↑	White	Black
	04	START	Green	White	44	START	White	Black
	21	"BLANK"	Red	N/A	45	STOP	White	Red
	22	O	Red	White	46	FW	White	Black
	23	OFF	Red	White	47	BW	White	Black
	24	STOP	Red	White	49	↑↑	White	Black
	61	"BLANK"	Yellow	N/A	81	"BLANK"	Black	N/A
	62	II	Yellow	White				

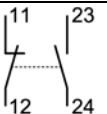
Part Code	Part Description	Contact Configuration	Typical Part Image
COP4G70	Momentary mushroom head button (P4G Green), 1NC/1NO contacts	 11 23 12 24 1NC/1NO	
COP4G71	Momentary mushroom head button (P4G Green), 2NC contacts	 11 21 12 22 2NC	
COP4G72	Momentary mushroom head button (P4G Green), 2NO contacts	 13 23 14 24 2NO	
<p>OPTION: Also available in Black (P4B) or Red (P4R)</p>			

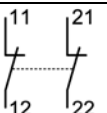
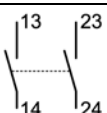
Emergency Stop Buttons



Part Code	Part Description	Contact Configuration	Typical Part Image
COP370	P3 E-stop mushroom head, pull to release, 1NC/1NO contacts	 1NC/1NO	
COP371	P3 E-stop mushroom head, pull to release, 2NC contacts	 2NC	
COP372	P3 E-stop mushroom head, pull to release, 2NO contacts	 2NO	
COP670	P6 E-stop mushroom head, twist to release, 1NC/1NO contacts	 1NC/1NO	
COP671	P6 E-stop mushroom head, twist to release, 2NC contacts	 2NC	
COP672	P6 E-stop mushroom head, twist to release, 2NO contacts	 2NO	
OPTION: Add suffix G to the above part codes to include a padlockable guard eg. COP370G Note: Padlock not included			

Part Code	Part Description	Contact Configuration	Typical Part Image
ABCS/SX CS	COY2170	Y21 E-stop mushroom head, key release, 1NC/1NO contacts	
ABCS/SX CS	COY2171	Y21 E-stop mushroom head, key release, 2NC contacts	
ABCS/SX CS	COY2172	Y21 E-stop mushroom head, key release, 2NO contacts	

Indicator Lamps

Part Code	Part Description	Voltage Range	Typical Part Image
CLLR7R1	Indicator lamp, Red (24-240Vac, 24-35Vdc)	20 - 250V AC/DC	
CLLG7G1	Indicator lamp, Green (24-240Vac, 24-35Vdc)		
CLLY7Y1	Indicator lamp, Yellow (24-240Vac, 24-35Vdc)		
CLLB7B1	Indicator lamp, Blue (24-240Vac, 24-35Vdc)		
CLLW7W1	Indicator lamp, White (24-240Vac, 24-35Vdc)		
CLLR7R2	Indicator lamp, Red (220-380Vac)	250 - 400V AC	
CLLG7G2	Indicator lamp, Green (220-380Vac)		
CLLY7Y2	Indicator lamp, Yellow (220-380Vac)		
CLLB7B2	Indicator lamp, Blue (220-380Vac)		
CLLW7W2	Indicator lamp, White (220-380Vac)		

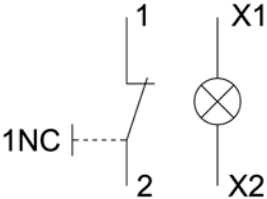

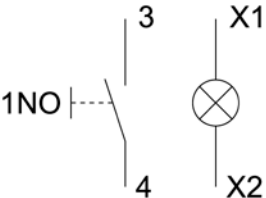







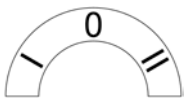
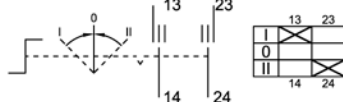

Illuminated Push Buttons

Part Code	Part Description	Contact Configuration/Voltage Range	Typical Part Image
COPR73R1	Illuminated Push Button, Red (1NC)	 <p>20 - 250V AC/DC</p>	
COPG73G1	Illuminated Push Button, Green (1NC)		
COPY73Y1	Illuminated Push Button, Yellow (1NC)		
COPB73B1	Illuminated Push Button, Blue (1NC)		
COPW73W1	Illuminated Push Button, White (1NC)		
COPR74R1	Illuminated Push Button, Red (1NO)	 <p>20 - 250V AC/DC</p>	
COPG74G1	Illuminated Push Button, Green (1NO)		
COPY74Y1	Illuminated Push Button, Yellow (1NO)		
COPB74B1	Illuminated Push Button, Blue (1NO)		
COPW74W1	Illuminated Push Button, White (1NO)		

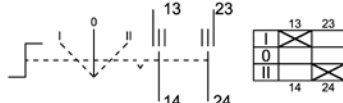

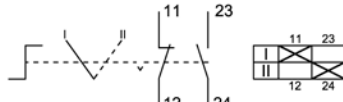

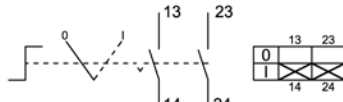
Small Handle Selector Switches

Part Code	Part Description	Label	Contact Schematic	Typical Part Image
COK47003	K4 3-position small handle, self-reset, "0-I-II"			
COK47204	K4 3-position small handle, self-reset, "I-0-II"			
COK57204	K5 3-position small handle, self-lock, "I-0-II"			
COK57003	K5 3-position small handle, self-lock, "0-I-II"			
COK67201	K6 2-position small handle, self-lock, "0-I"			
COK67002	K6 2-position small handle, self-lock, "I-II"			
COK87005	K8 3-position small handle, self-lock/reset, "0-•-I"			
<p>OPTION: Add suffix G to the above part codes to include a padlockable guard eg. COK47003G</p> <p>Note: Padlock not included</p>				

Large Handle Selector Switches

Part Code	Part Description	Label	Contact Schematic	Typical Part Image
COS47003	S4 3-position large handle, self-reset, "0-I-II"			
COS47204	S4 3-position large handle, self-reset, "I-0-II"			
COS57003	S5 3-position large handle, self-lock, "0-I-II"			
COS57204	S5 3-position large handle, self-lock, "I-0-II"			
COS67002	S6 2-position large handle, self-lock, "I-II"			
COS67201	S6 2-position large handle, self-lock, "0-I"			
COS87005	S8 3-position large handle, self-lock/reset, "0-I-I"			

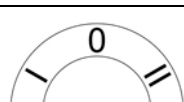
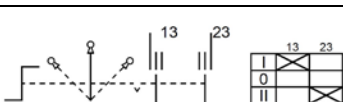
Key Switches

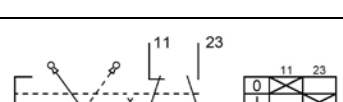
Part Code	Part Description	Label	Contact Schematic	Typical Part Image
COY5170	Y51 3-position key switch, self-lock, "I-0-II"			
COY5172	Y51 3-position key switch, self-lock, "I-0-II"			
COY6170	Y61 2-position key switch, self-lock, "0-I"			

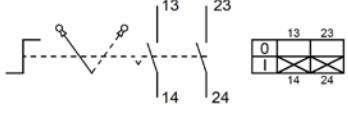
COY6172	Y61 2-position key switch, self-lock, "0-I"			
---------	---	---	--	--

Ammeters

Part Code		Measuring Method	Measuring Range	Overload Scale	Typical Part Image	
ABCS/SX	CAM7WAxx/1-2	1A CT current transformer	See scales below	x2		
PCS	CAM6WAxx/1-2					
ABCS/SX	CAM7WAxx/1-5	1A CT current transformer	See scales below	x5		
PCS	CAM6WAxx/1-5					
ABCS/SX	CAM7WAxx/5-2	5A CT current transformer	See scales below	x2		
PCS	CAM6WAxx/5-2					
ABCS/SX	CAM7WAxx/5-5	5A CT current transformer	See scales below	x5		
PCS	CAM6WAxx/5-5					
Ammeter Scale Options -						
CACZ0205-0-1A/□-□		1A or 5A current transformer	0--1A	2A or 5A		
CACZ0205-0-2.5A/□-□			0--2.5A	5A or 12.5A		
CACZ0205-0-5A/□-□			0--5A	10A or 25A		
CACZ0205-0-15A/□-□			0--15A	30A or 75A		
CACZ0205-0-25A/□-□			0--25A	50A or 125A		
CACZ0205-0-40A/□-□			0--40A	80A or 200A		
CACZ0205-0-50A/□-□			0--50A	100A or 250A		
CACZ0205-0-60A/□-□			0--60A	120A or 300A		
CACZ0205-0-75A/□-□			0--75A	150A or 375A		
CACZ0205-0-100A/□-□			0--100A	200A or 500A		
CACZ0205-0-150A/□-□			0--150A	300A or 750A		
CACZ0205-0-200A/□-□			0--200A	400A or 1000A		
CACZ0205-0-250A/□-□			0--250A	500A or 1250A		
CACZ0205-0-300A/□-□			0--300A	600A or 1500A		
CACZ0205-0-400A/□-□			0--400A	800A or 2000A		
CACZ0205-0-500A/□-□			0--500A	1000A or 2500A		
CACZ0205-0-600A/□-□			0--600A	1200A or 3000A		

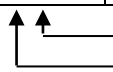
 "2" or "5" (x2 or x5 overload scale)
 "1" or "5" (1A or 5A current transformer)

Voltmeters

Part Code	Measuring Range	Typical Part Image
ABCS/SXCS	CVM7V25- EXM	
	0-25V AC	
ABCS/SXCS	CVM7V40-EXM	
	0-40V AC	
ABCS/SXCS	CVM7V150-EXM	
	0-150V AC	
ABCS/SXCS	CVM7V250-EXM	0-250V AC
	0-250V AC	
ABCS/SXCS	CVM7V500-EXM	0-500V AC
	0-500V AC	